

Product Data Sheet

Linear Actuator Controller



Standard Features:

- 3 user programmable actuator travel set points
- 12 VDC (nominal)
- 7.5 Amp fuse
- Control box and wired 3-button switch: No IP rating (not waterproof)
- Works with Concentric International's Light Duty and Medium Duty series actuators with potentiometers
- Operating temperature range: -4°F [-20°C] to +176°F [+80°C]

Each Kit Contains the Following Components:

- (1) Control Unit
- (1) Control unit wire harness
- (1) Wired 3-button switch (M4-0.7 mounting holes)
- (1) 3-button switch wire harness
- (1) Double-sided tape
- (1) Mounting hardware

Optional Accessories:

- 10' Linear actuator cable extension harness (part no: LA-EXTHARN)
- Linear actuators 2", 4", 6", 8", 10", 12" (actuator must have a potentiometer)

Explanation / Overview:

- This unit features 3 user defined presets that are easily programmed via the wired 3-button switch to precisely control one linear actuator. This allows you to preset up to 3 different repeatable stops in the actuator travel. By momentarily pressing the corresponding button on the wired 3-button switch or using your own push button switches with the optional input wires (wires included), you can extend the actuator to the desired preset stop point.

Operations / Programming:

To move actuator extension tube in and out:

1. Press buttons 2 & 3 at the same time to make the actuator extend.



2. Press buttons 1 & 2 at the same time to make the actuator retract.



To program preset positions 1, 2, and 3:

1. Position the actuator extension tube to where you would like Preset #1 to be located.

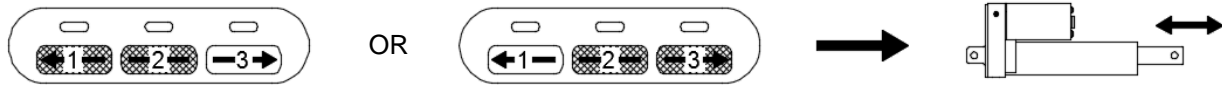

2. Press and hold the number 1 button for 5 seconds.
 - a. The LED will flash to indicate the setting has been learned and stored.

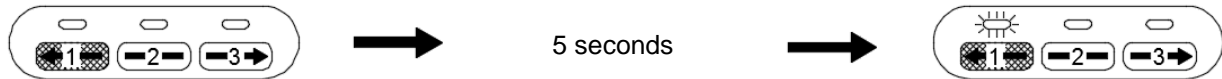

3. Position the actuator extension tube to where you would like Preset #2 to be located.

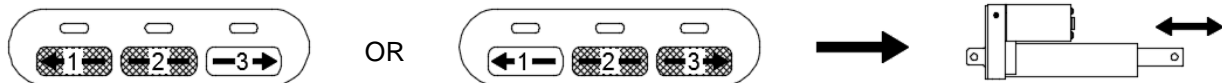

4. Press and hold the number 2 button for 5 seconds.
 - a. The LED will flash to indicate the setting has been learned and stored.

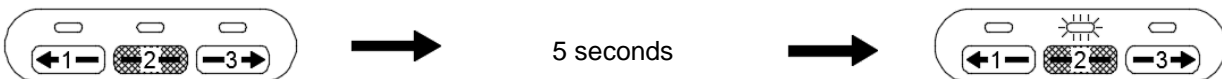

5. Position the actuator extension tube to where you would like Preset #3 to be located.



6. Press and hold the number 3 button for 5 seconds.
 - a. The LED will flash to indicate the setting has been learned and stored.

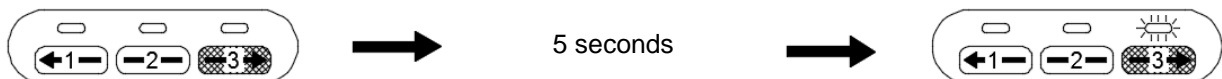

Operation Notes:

- The control unit will remember the preset positions after its power is removed.
- Programming a new preset position will overwrite any previous preset position stored for that button number.
- The presets can be in any position throughout the stroke of the actuator. They do not need to be in order along the travel of the actuator stroke. They do not need to be programmed in any certain order.
- The 3 optional input wires (white – preset #1, green – preset #2, blue – preset #3) are ground inputs. When a ground is applied to any of these wires, the actuator will go to the specified preset position. Momentary, normally-open switches should be used with these inputs. Movement of the actuator begins as soon as the switch is closed (leading edge of the ground pulse).

- The white, green, and blue wires cannot be used to program preset positions – user must use the wired 3-button switch to program preset positions.
- The white, green, and blue wires cannot be used in pairs (white & green -or- green & blue) to extend or retract the actuator – user must use the wired 3-button switch to extend or retract the actuator.
- Proper wiring is critical to the correct operation of this unit. Inspect all wiring to be certain of proper connections, good quality ground, and proper fusing. Also check wire routing, keeping wires away from potential damage such as moving parts.

Dimension Diagram:

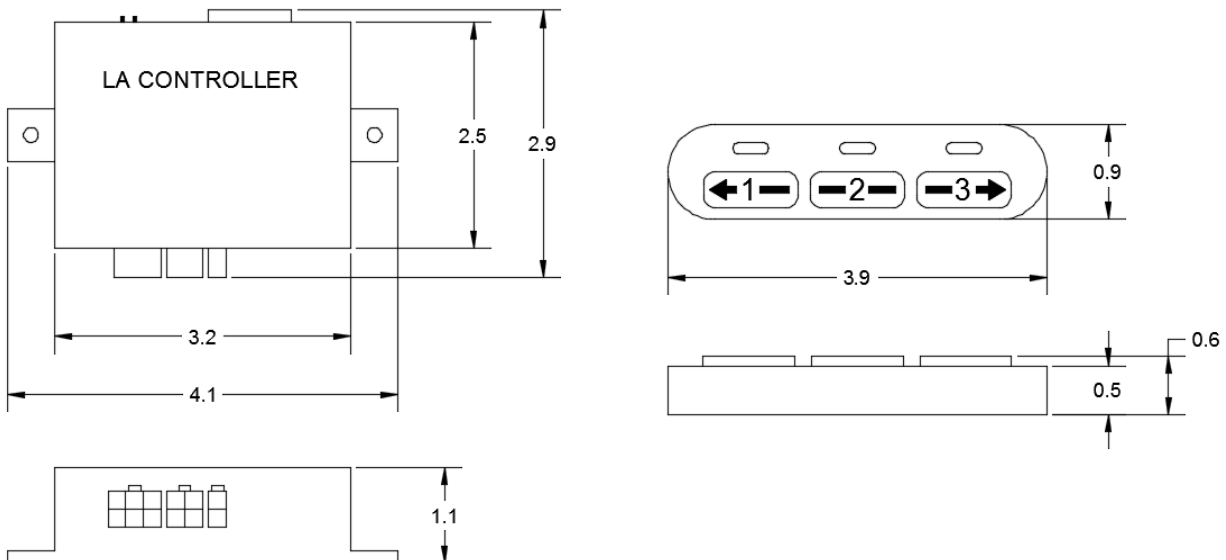

Wiring Diagrams:

- LA-CONTROLLER

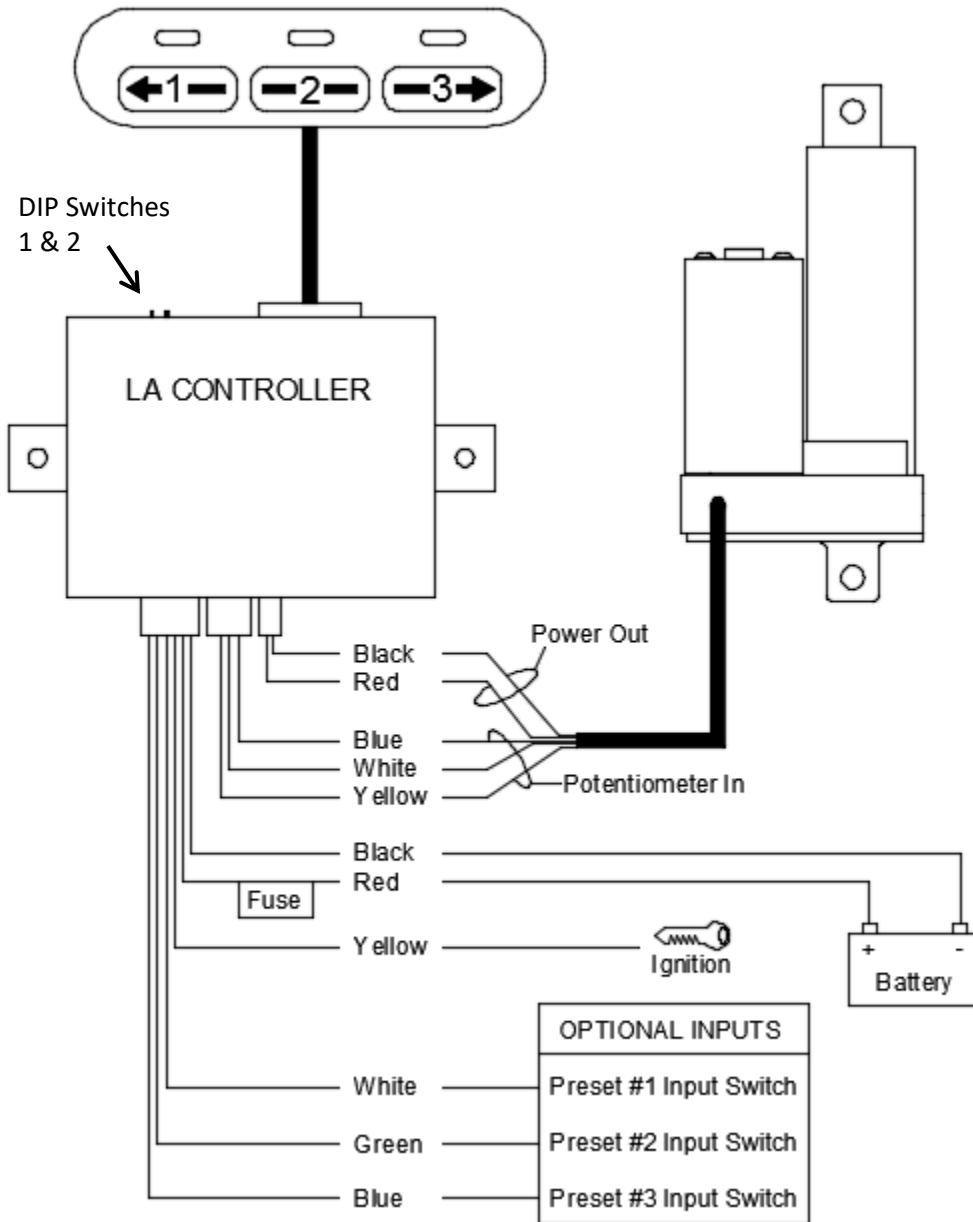

- LA-CONTROLLER with Optional Momentary Push Buttons

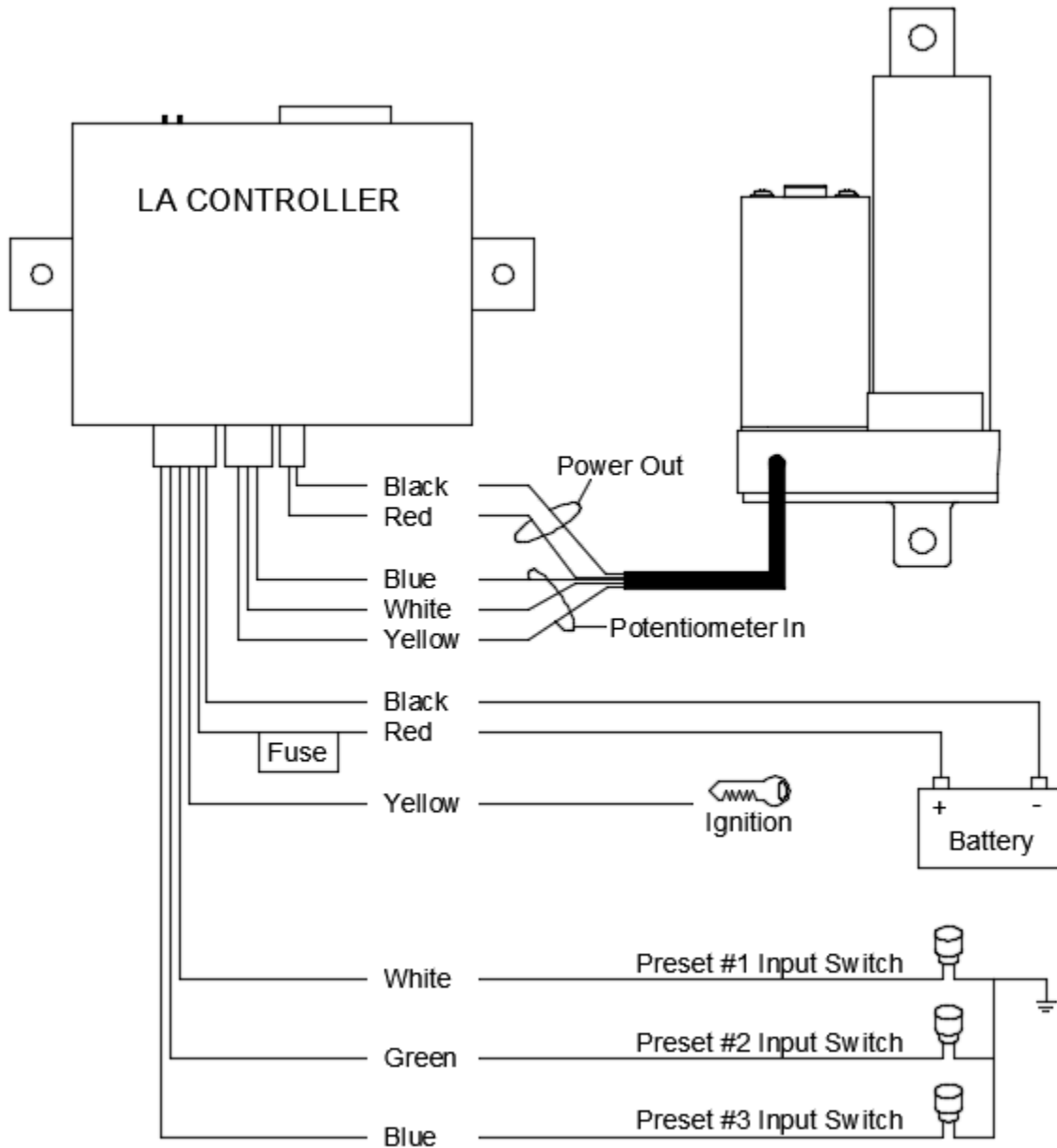

- LA-CONTROLLER Wire Connections

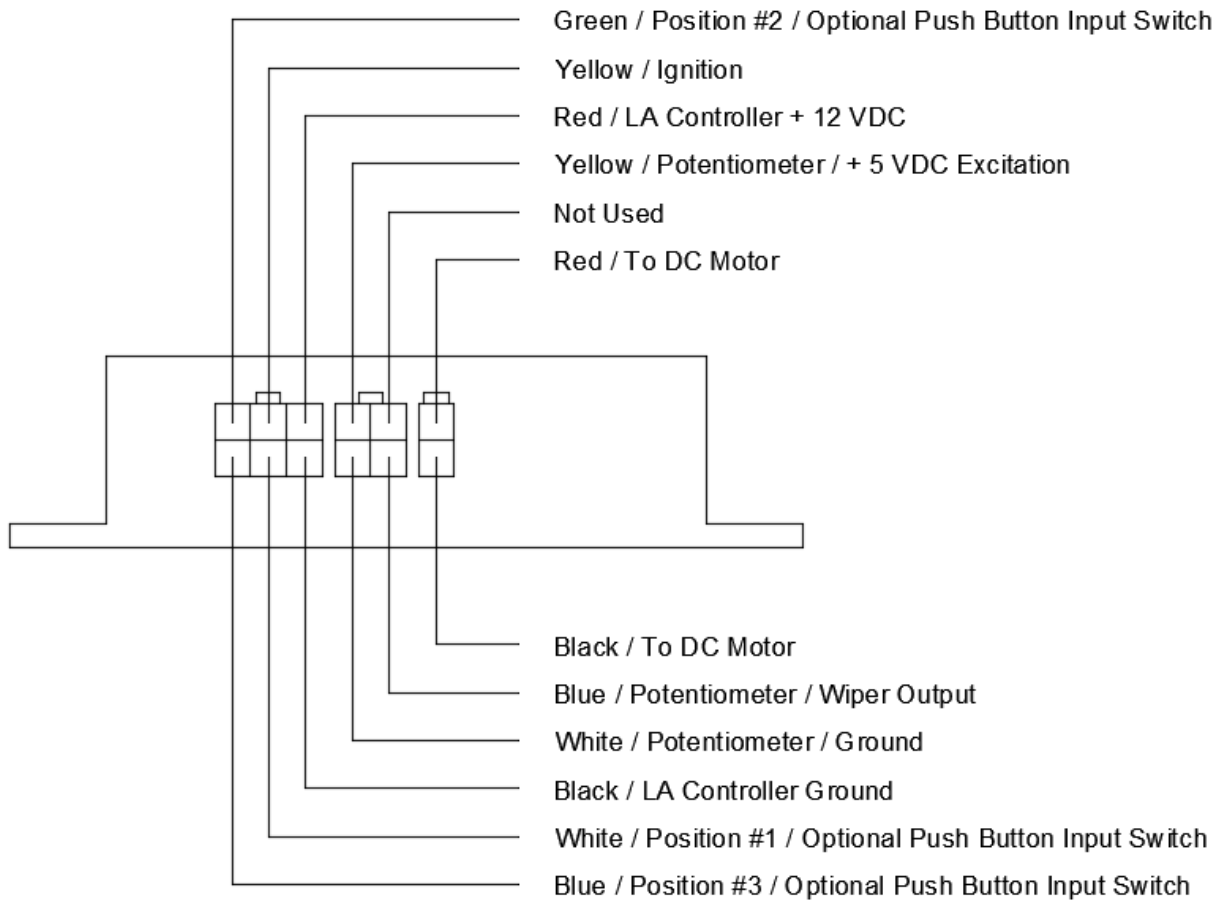

Mounting:

The control unit and the wired 3-button switch must be mounted out of the weather to avoid moisture (they are not waterproof).

The wired 3-button switch can be mounted in a variety of ways. Below you will find some mounting options.

Use the supplied double-sided tape to mount the switch to any flat surface.

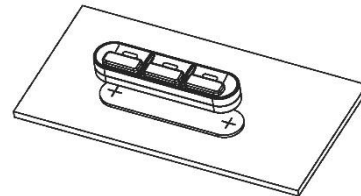

Use the supplied mounting bolts and support bracket for a more secure mounting option. The support bracket can be used as a template for marking and drilling the mounting holes.

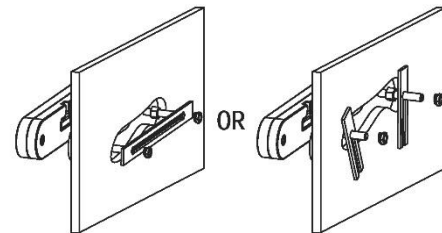

The rear of the switch is reversible so that the switch wire harness can exit the top or bottom of the switch housing.

1) Remove the rear of the switch by gently separating the front and rear halves. The front and rear halves simply snap together and can be separated by inserting a thin blade in between the front and rear halves.

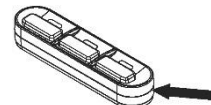

2) Reverse the rear of the display.

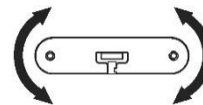

3) Snap the front and rear halves back together.

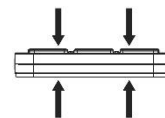

DIP Switch Settings:

After changing DIP switch settings, you must cycle the power to the LA-Controller for the change to take effect.

DIP Switch #1 → OFF (switch position → up)
DIP Switch #2 → OFF (switch position → up)

With power applied to the LA-Controller – without power applied to the YELLOW ignition wire:

- All buttons on the wired 3-button switch function normally.
- All 3 wires for the optional push button input switches function normally.

With power applied to the YELLOW ignition wire:

- The wired 3-button switch does not work.
- The 3 wires for the optional push button input switches do not work.

DIP Switch #1 → ON (switch position → down)
DIP Switch #2 → OFF (switch position → up)

With power applied to the LA-Controller – without power applied to the YELLOW ignition wire:

- The wired 3-button switch does not work.
- The 3 wires for the optional push button input switches do not work.

With power applied to the YELLOW ignition wire:

- All buttons on the wired 3-button switch function normally.
- All 3 wires for the optional push button input switches function normally.
- The LED above a Preset button stays ON when using a Preset button or the optional input wire for that Preset.

DIP Switch #1 → OFF (switch position → up)
DIP Switch #2 → ON (switch position → down)

When power is first applied to the LA-Controller – without power applied to the YELLOW ignition wire:

- Actuator extension stays where it is at power up.
- The wired 3-button switch functions normally.
- All 3 wires for the optional push button input switches function normally.

With power applied to the YELLOW ignition wire:

- Actuator extension moves to preset #2.
- The wired 3-button switch does not work.
- The 3 wires for the optional push button input switches do not work.

Power removed from the YELLOW ignition wire:

- Actuator extension moves to preset #1.
- All buttons on the wired 3-button switch function normally.
- All 3 wires for the optional push button input switches function normally.

Until power to the LA-Controller is removed, the actuator continues to cycle between preset #2 and preset #1 as the YELLOW ignition wire is powered and power is removed from the ignition wire.

DIP Switch #1 → ON (switch position → down)
DIP Switch #2 → ON (switch position → down)

When power is first applied to the LA-Controller – without power applied to the YELLOW ignition wire:

- Actuator extension stays where it is at power up.
- The wired 3-button switch does not work.
- The 3 wires for the optional push button input switches do not work.

With power applied to the YELLOW ignition wire:

- Actuator extension moves to preset #2.
- All buttons on the wired 3-button switch function normally.
- All 3 wires for the optional push button input switches function normally.

Power removed from the YELLOW ignition wire:

- Actuator extension moves to preset #1.
- The wired 3-button switch does not work.
- The 3 wires for the optional push button input switches do not work.

Until power to the LA-Controller is removed, the actuator continues to cycle between preset #2 and preset #1 as the YELLOW ignition wire is powered and power is removed from the ignition wire.

Ordering Key:

Part Number	Description
LA-CONTROLLER	Controller 3-Position
LA-EXTHARN	10' extension wire harness for LA-Controller/actuator connection
LACT-KEYPAD	3-Button keypad, 3-button keypad harness, multi-colored main harness
LACT-KEYPADHARN	Wire harness for LA-Controller keypad
LACT-MAINHARN	Main harness for LA-Controller

Terms of Use

The user is responsible for determining the suitability of Concentric International products for specific applications. Due to continuous development in order to improve its products, Concentric International products are subject to change without prior notice. Concentric International reserves the right to discontinue the sale of any products at any time.