

Product Data Sheet

Dual Linear Actuator Control



Standard Features:

- Control 1 or 2 actuators with one controller
- Actuators can be controlled individually, in sequence, or simultaneously.
- 3 user programmable actuator travel set points for each actuator
- 12 VDC (nominal)
- 15 Amp fuse
 - 7.5 Amp limit per actuator
- Control unit:
 - Wide: 3.9" (5.1" with mounting tabs)
 - Deep: 3.2" (3.7" including connectors and switches)
 - Tall: 1.3"
 - Mount holes: 0.193" wide slot
- Wired 3-button switch:
 - Wide: 3.9"
 - Deep: 0.9"
 - Tall: 0.5" (0.6" including push buttons)
- Control box and wired 3-button switch: No IP rating (not waterproof)
- Works with Concentric International's Light Duty and Medium Duty series actuators with potentiometers
- Operating temperature range: -4°F [-20°C] to +176°F [+80°C]

Each Kit Contains the Following Components:

- (1) Control Unit
- (1) Control unit wire harness
- (1) Wired 3-button switch (M4-0.7 mounting holes)
- (1) 3-button switch wire harness
- (1) Double-sided tape
- (1) Mounting hardware

Optional Accessories:

- 10' Linear actuator cable extension harness (part no: LA-EXTHARN)
- Linear actuators 2", 4", 6", 8", 10", 12" (actuator must have a potentiometer)

Explanation / Overview:

This unit can control 1 or 2 actuators – individually, in sequence, or simultaneously. Each actuator can have up to 3 user defined presets that are easily programmed via the wired 3-button switch. This allows you to preset up to 3 different repeatable stops in the actuator travel for each actuator. With the selection switch on the control unit in the correct associated position, by momentarily pressing the corresponding button on the wired 3-button switch or using your own push button switches with the optional input wires (wires included), you can extend the actuators to the desired preset stop points.

Operations / Programming:

To manually control or program presets for a single actuator, move the selector switch to position 1 (for actuator 1) or position 3 (for actuator 2) – depending on which actuator you want to work with. The picture below shows the selector switch in position 1 for actuator 1. Presets for actuators 1 and 2 are set separately (up to 3 presets per actuator). Additional information on the function of the 3 position slide switch is in the sections below on how to program and run in different modes.

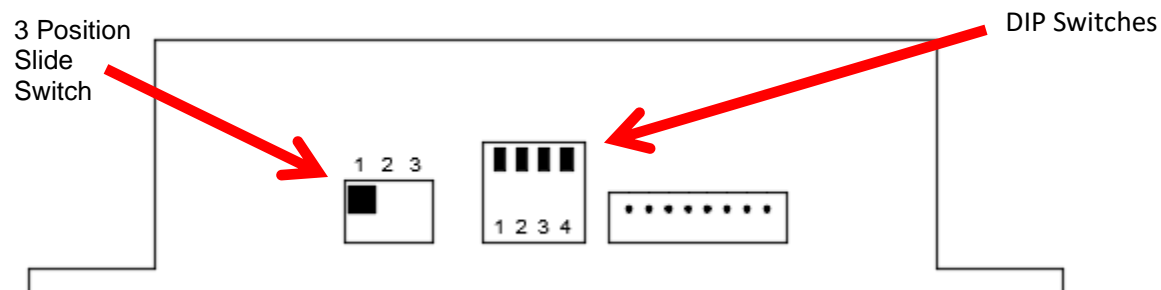

To move actuator extension tube in and out:

1. Press buttons 2 & 3 at the same time to make the actuator extend.



2. Press buttons 1 & 2 at the same time to make the actuator retract.



To program preset positions 1, 2, and 3:

3. Position the actuator extension tube to where you would like Preset #1 to be located.

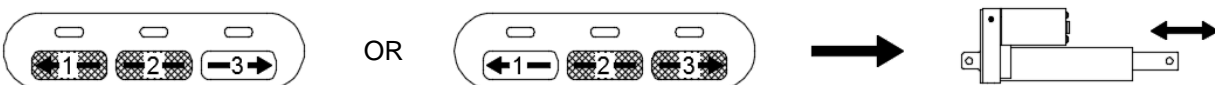

4. Press and hold the number 1 button for 5 seconds.
 - a. The LED will flash to indicate the setting has been learned and stored.

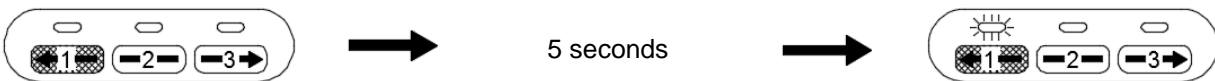

5. Position the actuator extension tube to where you would like Preset #2 to be located.

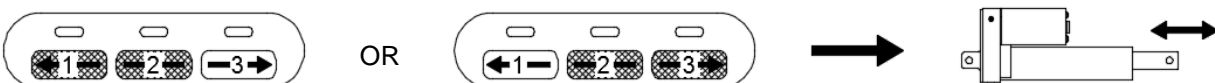

6. Press and hold the number 2 button for 5 seconds.
 - a. The LED will flash to indicate the setting has been learned and stored.

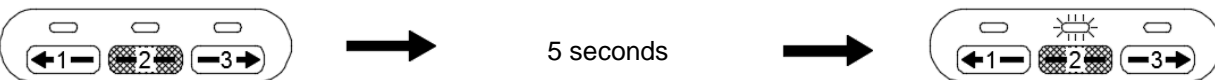

7. Position the actuator extension tube to where you would like Preset #3 to be located.

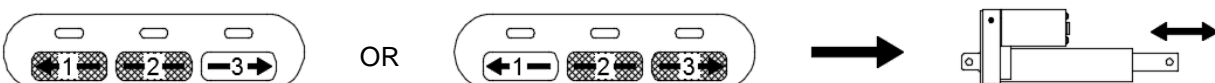

8. Press and hold the number 3 button for 5 seconds.
 - a. The LED will flash to indicate the setting has been learned and stored.

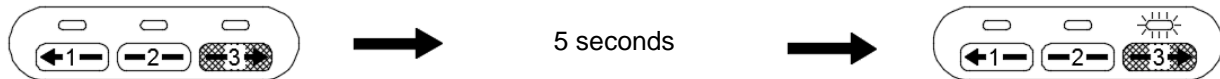

Operation Notes:

- The control unit will remember the preset positions after its power is removed.
- Programming a new preset position will overwrite any previous preset position stored for that combination of actuator and button number.
- The presets can be in any position throughout the stroke of the actuator. They do not need to be in order along the travel of the actuator stroke. They do not need to be programmed in any certain order.
- The 3 optional input wires (blue – preset #1, green – preset #2, white – preset #3) are ground inputs. When a ground is applied to any of these wires, the actuator will go to the specified preset position. Momentary, normally-open switches should be used with these inputs. Movement of the actuator begins after the switch is closed and then opened (trailing edge of the ground pulse).
- The blue, green, and white wires cannot be used to program preset positions – user must use the wired 3-button switch to program preset positions.
- The blue, green, and white wires cannot be used in pairs (blue & green -or- green & white) to extend or retract the actuator – user must use the wired 3-button switch to extend or retract the actuator.
- Proper wiring is critical to the correct operation of this unit. Inspect all wiring to be certain of proper connections, good quality ground, and proper fusing. Also check wire routing, keeping wires away from potential damage such as moving parts.
- How the LA-Dual-Control functions when it loses connection to one of the two actuators when operating in a dual actuator mode:
 - When one of the two actuators' motor is disconnected, the other actuator slows down in an attempt to synchronize positions, but continues to its target position.
 - When one of the two actuators' potentiometer is disconnected, it attempts a short move when commanded, but then stops abruptly, as its position cannot be determined. The other actuator slows down in an attempt to synchronize positions, but continues to its target position.
 - The controller uses a form of pulse width modulation in controlling the speed of the actuators.

DIP Switch Settings:

Refer to the drawing above showing which DIP switch is which (switches numbered 1 – 4). After changing DIP switch settings, you should cycle the power to the LA-Dual-Control for the change to take effect.

DIP Switch		Function	Action	Reason/Examples
1	ON	Operates only when ignition IS present.	The unit will operate only when the yellow ignition wire receives +12VDC.	If you want to control items when the ignition is ON .
	OFF	Operates only when ignition IS NOT present.	The unit will operate only when the yellow ignition wire is NOT receiving +12VDC.	If you want to raise/lower your trunk when the car is OFF .
2	ON	Auto return to position #1 with loss of ignition. Auto return to position #2 with ignition.	When +12VDC is removed from the yellow ignition wire the actuator will travel to position #1. When the yellow ignition wire receives +12VDC the actuator will travel to position #2. Manual control is available when the yellow ignition wire receives +12VDC.	If you want your trunk, running boards, steering column, etc. to move automatically when you turn the ignition ON/OFF . NOTE: DIP switch #1 must be ON for functions of switch #2 to work.
	OFF	Nothing happens with ignition cycle.	When the key is turned ON or OFF , the actuator will remain at the same location.	If you do not want automatic movement when you turn the vehicle ON or OFF .
3	ON	2 stage feature ON . This feature works after programming a start and end point. Once in the run mode, pressing button 1 will initiate the two stage sequence by moving actuator 1 from the preset start point to the end point. Once actuator 1 has reached its end point, actuator 2 will begin moving from the preset starting point to the end point. Pressing button 3 will reverse the sequence, retracting actuator 2 first, then retracting actuator 1, both back to the starting point. Pressing button 2 will only move the actuators 1 stage. For example, after pressing button 2, if the actuators were at their starting point, the controller will only move actuator 1 from the starting point to the end point. If the actuators were at their end point, the controller will only move actuator 2 from its end point to the start point. Pressing button 1 or 3 after pressing button 2 will complete the second stage of the sequence.		
	OFF	2 stage feature OFF .		
4	ON	Retreat safety ON . In this feature, the controller will be able to sense if something is in the way that is preventing the actuator from retracting completely. The controller will do a speed check after reading current actuator position value, retract a little, and perform another speed check. Speed check will respond “normal” or “error”. If there is an “error” response, the actuators are to stop immediately and extend to their maximum preset.		
	OFF	Retract safety OFF .		

Steps to program and run actuators individually:

1. Connect both actuators to the Dual Controller
 - a. Can also perform this function with just one actuator connected
2. Connect the Dual Controller to power
3. Set all DIP switches to the OFF position
4. Do not connect the yellow ignition wire to power
5. Apply power to the controller
6. Move the 3-position slide switch to position 1
7. See the section on Operation / Programming (above) to input up to 3 set points for actuator 1 into memory
8. Move the 3-position slide switch to position 3
9. See the section on Operation / Programming (above) to input up to 3 set points for actuator 2 into memory
10. Move the 3-position slide switch to either position 1 or 3 to control actuator 1 or 2 respectively
11. Use the 3-button switch (or the optional input switches) to control the actuator position
12. With the 3-position slide switch set to position 2:
 - a. You can simultaneously run both actuators – but just for positions 1 & 2 – with either the buttons for 1 and 2, or you can use the BLUE or GREEN wire.
 - i. Button 3 and the WHITE wire will not work.

Steps to program and run actuators in sequential mode:

1. Connect both actuators to the Dual Controller
2. Connect the Dual Controller to power
3. Set the 4 DIP switches as follows: OFF, OFF, ON, OFF (switch 1, 2, 3, 4)
4. Apply power to the controller
 - a. Do not apply power to the yellow (ignition) wire
5. Move the 3-position switch to position 1
6. See the section on Operation / Programming (above) to set desired position 1 and 3 (START and END positions) using switch buttons 1 and 3 for programming
7. Move the 3-position switch to position 3
8. See the section on Operation / Programming (above) to set desired position 1 and 3 (START and END positions) using switch buttons 1 and 3 for programming
9. Move the 3-position switch to position 2
10. Pressing switch button 1
 - a. First – Actuator 2 will move to the programmed START position
 - b. Second – Actuator 1 will move to the programmed START position
11. Pressing button 3
 - a. First – Actuator 1 will move to the programmed END position
 - b. Second – Actuator 2 will move to the programmed END position
12. Pressing button 2
 - a. If both actuators are at the programmed START position
 - i. Actuator 1 will move to the programmed END position
 - ii. Actuator 2 will not move
 - b. If both actuators are at the programmed END position
 - i. Actuator 2 will move to the programmed START position
 - ii. Actuator 1 will not move

- c. If both actuators are not at the programmed START or END position (if button 2 has been pressed)
 - i. Pressing button 1 will complete the cycle – moving both actuators back to the programmed START position
 - ii. Pressing button 3 will complete the cycle – moving both actuators to the programmed END position

Steps to program and run actuators in simultaneous mode:

To program and run the dual controller so that 2 actuators will operate at the same time, and will do that based on when the ignition is turned ON or OFF, follow the following steps:

1. Connect both actuators to the Dual Controller
2. Connect the Dual Controller to power
3. Set all DIP switches to the OFF position
4. Apply power to the controller
5. Move the 3-position slide switch to position 1
6. Use the 3-button switch to adjust actuator 1 to the position you want for actuator 1 when the ignition is OFF
 - a. Do NOT program this set point.
7. Move the 3-position slide switch to position 3
8. Use the 3-button switch to adjust actuator 2 to the position you want for actuator 2 when the ignition is OFF
 - a. Do NOT program this set point.
9. Move the 3-position slide switch to position 2
10. Using the 3-button switch, press and hold switch 1 till the light for switch 1 turns ON
 - a. This programs position 1 (ignition OFF) for both actuators.
11. Move the 3-position slide switch to position 1
12. Use the 3-button switch to adjust actuator 1 to the position you want for actuator 1 when the ignition is ON
 - a. Do NOT program this set point.
13. Move the 3-position slide switch to position 3
14. Use the 3-button switch to adjust actuator 2 to the position you want for actuator 2 when the ignition is ON
 - a. Do NOT program this set point.
15. Move the 3-position slide switch to position 2
16. Using the 3-button switch, press and hold switch 2 till the light for switch 2 turns ON
 - a. This programs position 2 (ignition ON) for both actuators.
17. Leave the 3-position slide switch in position 2
18. Set the DIP switches to ON, ON, OFF, ON (switch 1, 2, 3, 4)
19. Connect the yellow wire to the ignition source
20. When the ignition is OFF, both actuators will move simultaneously to their position 1
21. When the ignition is ON, both actuators will move simultaneously to their position 2
22. The controller will attempt to have both actuators reach their respective stop positions at the same time

Mounting:

The control unit and the wired 3-button switch must be mounted out of the weather to avoid moisture (they are not waterproof).

The wired 3-button switch can be mounted in a variety of ways. Below you will find some mounting options.

Use the supplied double-sided tape to mount the switch to any flat surface.

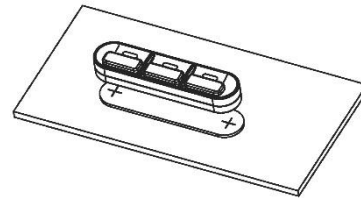

Use the supplied mounting bolts and support bracket for a more secure mounting option. The support bracket can be used as a template for marking and drilling the mounting holes.

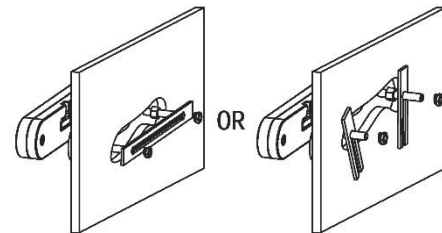

The rear of the switch is reversible so that the switch wire harness can exit the top or bottom of the switch housing.

1) Remove the rear of the switch by gently separating the front and rear halves. The front and rear halves simply snap together and can be separated by inserting a thin blade in between the front and rear halves.

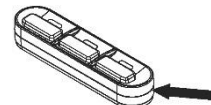

2) Reverse the rear of the display.

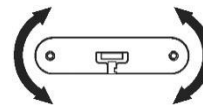

3) Snap the front and rear halves back together.

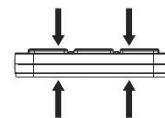

Dimension Diagram:

- LA-DUAL-CONTROL

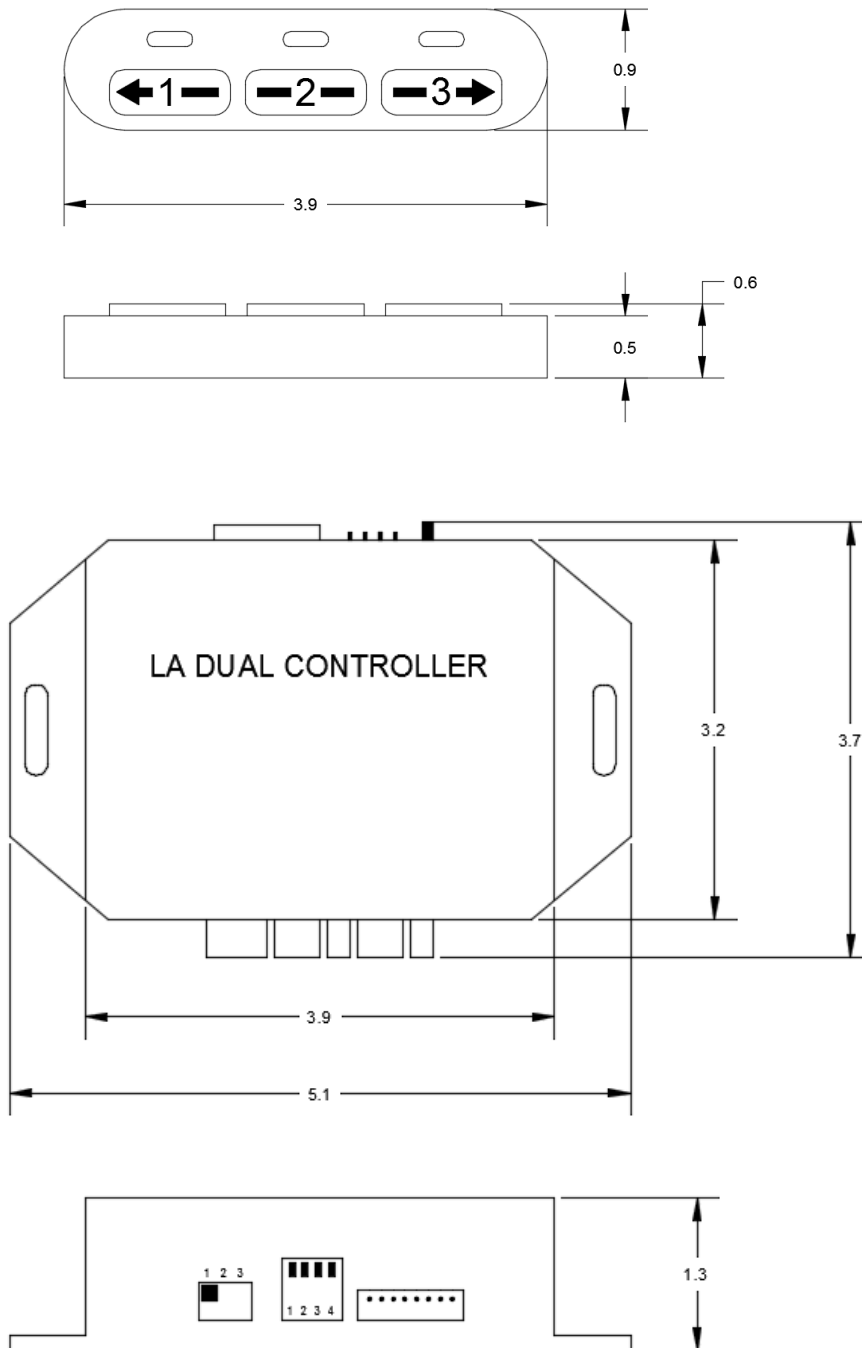

Wiring Diagrams:

- LA-DUAL-CONTROL

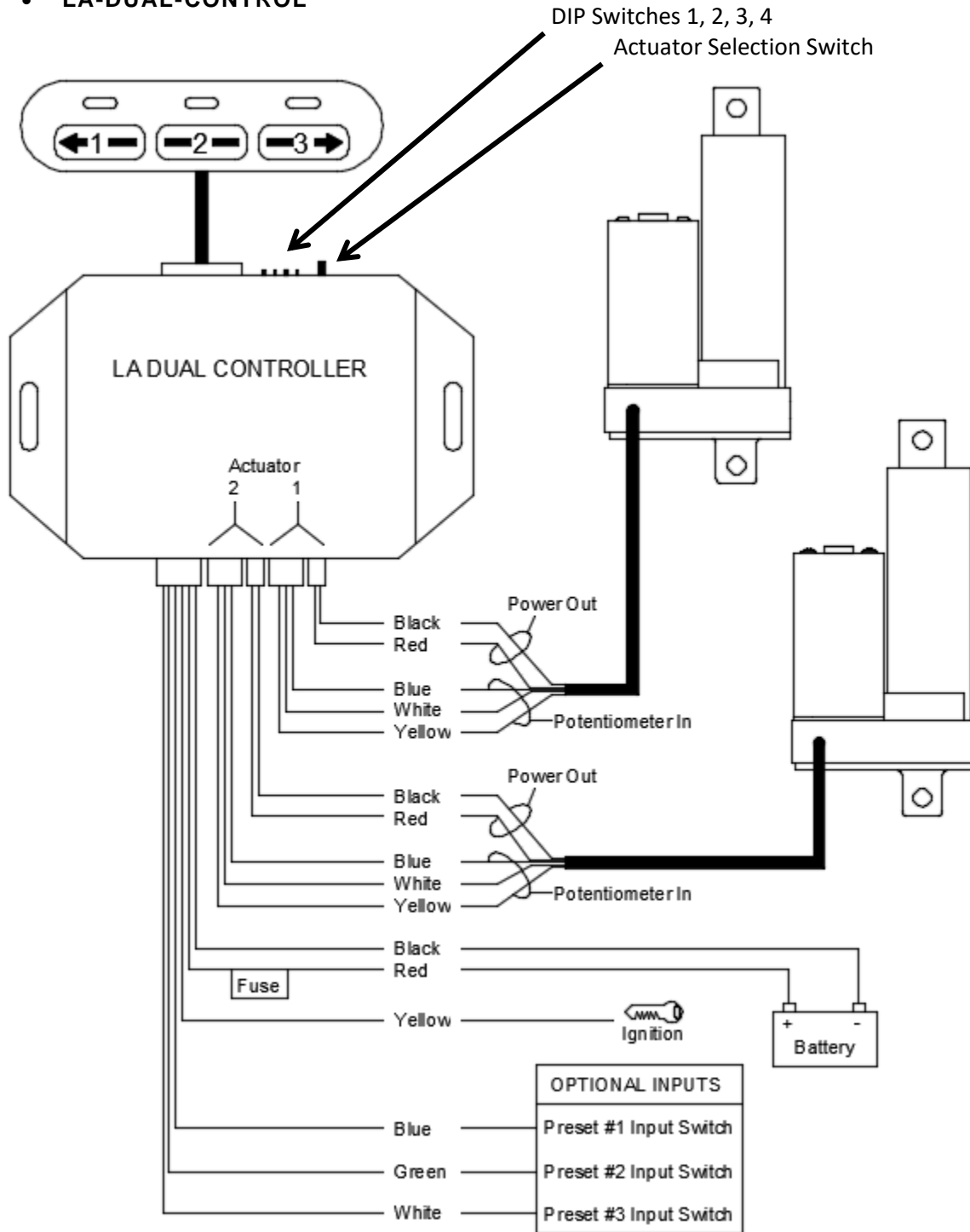

- LA-DUAL-CONTROL with Optional Momentary Push Button Switches

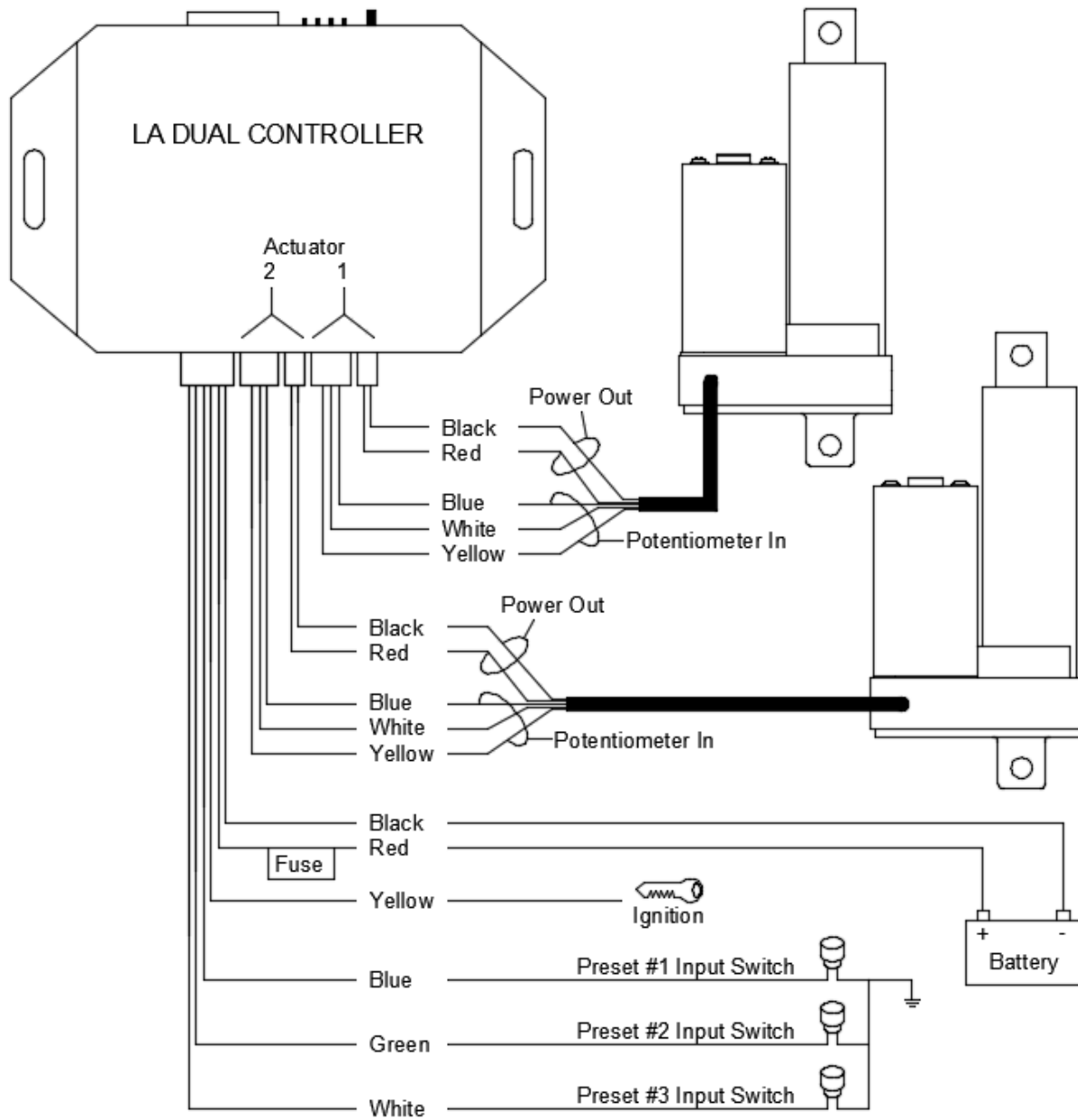

- **LA-DUAL-CONTROL Wire Connections**

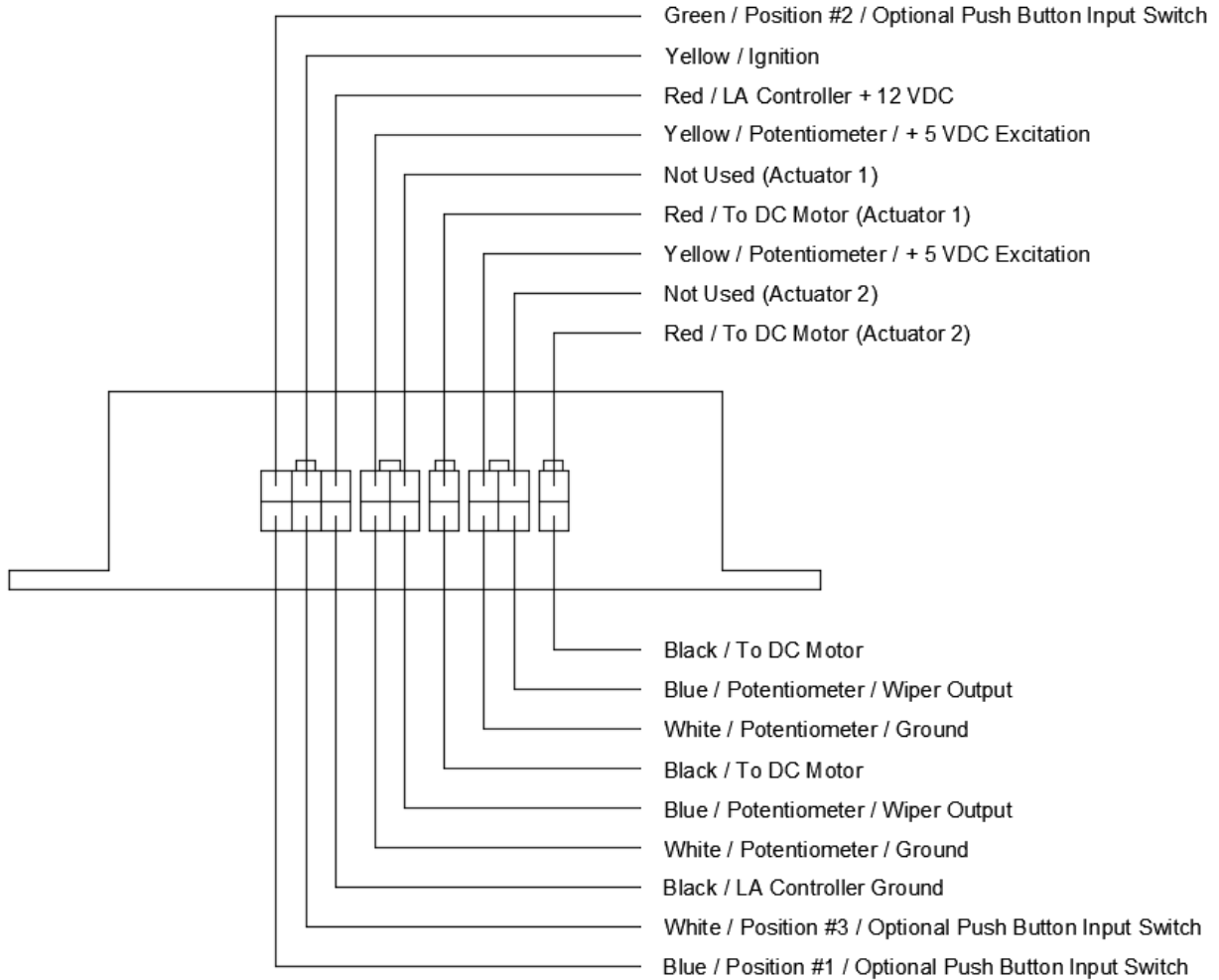

Ordering Key:

Part Number	Description
LA-DUAL-CONTROL	Controller Dual 3-Position
LA-EXTHARN	10' extension wire harness for LA-Dual-Controller/actuator connection
LACT-KEYPAD	3-Button keypad, 3-button keypad harness, multi-colored main harness
LACT-KEYPADHARN	Wire harness for LA-Dual-Controller keypad
LACT-MAINHARN	Main harness for LA-Dual-Controller

Terms of Use

The user is responsible for determining the suitability of Concentric International products for specific applications. Due to continuous development in order to improve its products, Concentric International products are subject to change without prior notice. Concentric International reserves the right to discontinue the sale of any products at any time.